

Doll Cradle

Dimensions 20"w x 12"h x 15"d

This doll cradle is the perfect gift for a young daughter or granddaughter. Shown here in pre-finished cherry PureBond® veneer core hardwood plywood. *This cradle is a toy and not intended for use with infants.*



PLEASE READ AND FOLLOW ALL SAFETY PRECAUTIONS NOTED ON PAGE 5.

Columbia Forest Products is North America's largest manufacturer of hardwood plywood and hardwood veneer, a leader in sustainable forestry, and innovator of soy-based formaldehyde-free PureBond® technology.

EASY SPECIAL ORDER*: Stock items are available at most Home Depot stores. Don't see what you need on the shelves? Ask the Associates at the ProDesk for assistance to order **anything** you need: species like Cherry, Walnut, Maple or even exotics. Need a special thickness or an MDF or particleboard core? We can get it for you. **As little as 1 sheet**, shipped right to the store. (Ask the ProDesk Associate for lead times and pricing information.)

*At this time, PureBond® plywood is not stocked or offered through special order in The Home Depot stores in AZ, CO, ID, NM, NV, OR, UT, or WA.

Detail of inside corner of the head of the cradle frame.



Materials List

- 1 Sheet (or less) 1/2" thick 4x8' veneer core hardwood plywood
 - 1 Roll matching edgebanding (such as [BAND-IT peel and stick wood veneer edgebanding](#) available through special order at The Home Depot.)* Iron-on edging could be difficult to apply on inside curves.
 - 1 Bottle wood glue
 - Brads or dowels (optional construction)
- * Please follow the installation instructions of edging manufacturer.

Doll Cradle - Cut List

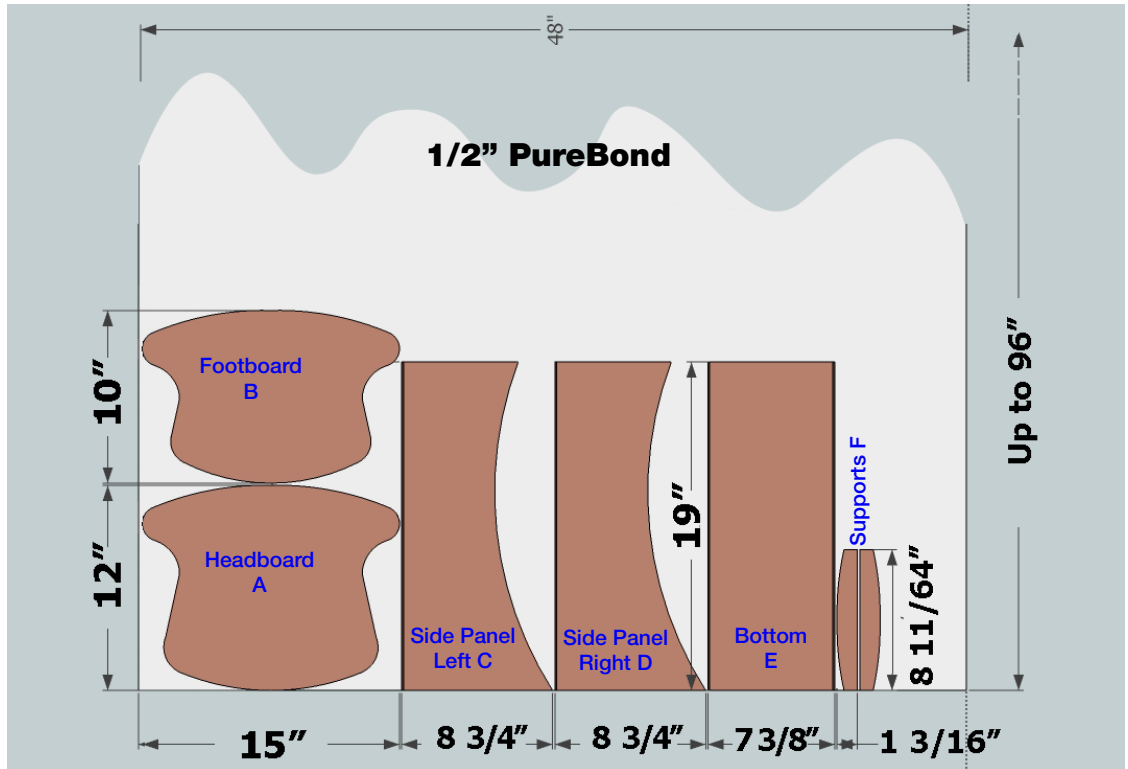

PLEASE READ AND FOLLOW ALL SAFETY PRECAUTIONS NOTED ON PAGE 5.

Columbia Forest Products is North America's largest manufacturer of hardwood plywood and hardwood veneer, a leader in sustainable forestry, and innovator of soy-based formaldehyde-free PureBond® technology.

EASY SPECIAL ORDER*:

Stock items are available at most Home Depot stores. Don't see what you need on the shelves? Ask the Associates at the ProDesk for assistance to order **anything** you need: species like Cherry, Walnut, Maple or even exotics. Need a special thickness or an MDF or particleboard core? We can get it for you. **As little as 1 sheet**, shipped right to the store. (Ask the ProDesk Associate for lead times and pricing information.

*At this time, PureBond® plywood is not stocked or offered through special order in The Home Depot stores in AZ, CO, ID, NM, NV, OR, UT, or WA.

Part ID	Quantity	Component	Width	Length	Thickness	Notes
A	1	Headboard	15"	12"	1/2"	
B	1	Footboard	15"	10"	1/2"	
C	1	Side Panel, Left	19"	8 3/4"	1/2"	Bottom Edge Beveled, Right & Left Sides mirror each other
D	1	Side Panel, Right	19"	8 3/4"	1/2"	Bottom Edge Beveled, Right & Left Sides mirror each other
E	1	Bottom	19"	7 3/8"	1/2"	Beveled on both edges
F	2	Support	1 3/16"	8 11/64"	1/2"	3/4" w at smallest point

PLUS: wood glue, brads or dowels (optional) and edging. See page 1.

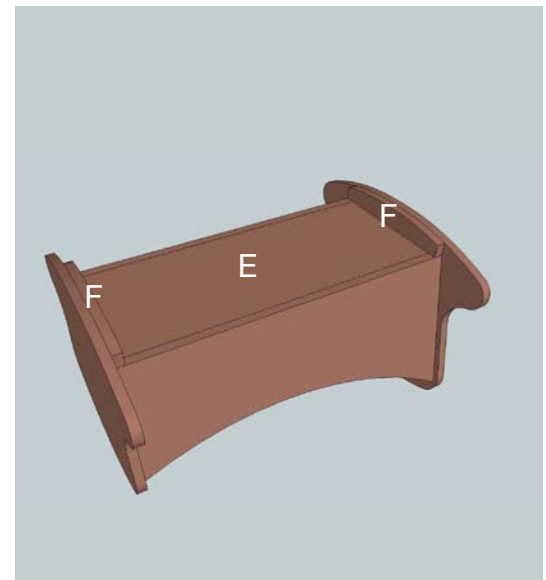
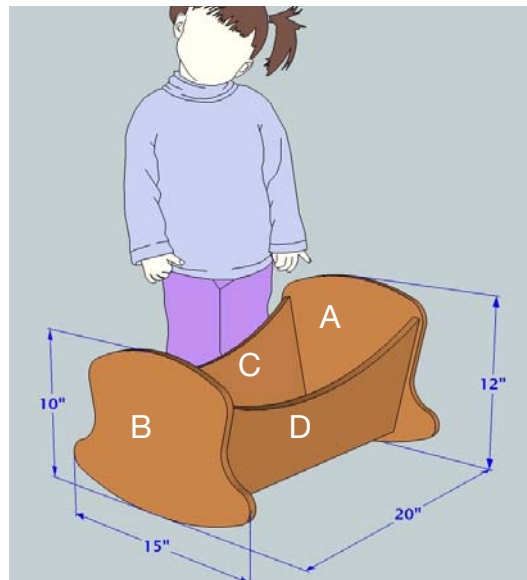

Doll Cradle - Instructions

Step 1

- Cut all parts to size. See cut list on page 2.
- **Cut Side Panels.** Refer to Figure A.
- **Cut 78° / 12° angle on bottom edge.** (Hint: you probably want to cut the angles on the Cradle Bottom as well while you have the saw blade angle set) See Figure B.
- Note that **Left and Right Sides MIRROR each other.** (Bevel faces opposite way)

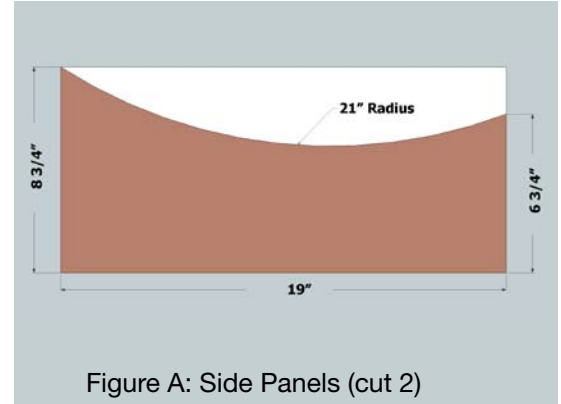

Figure A: Side Panels (cut 2)

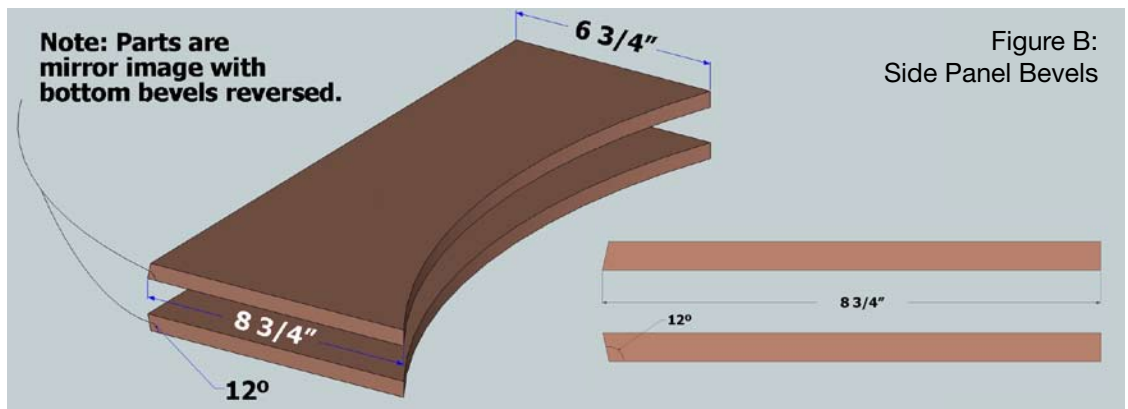

Figure B: Side Panel Bevels

PLEASE READ AND FOLLOW ALL SAFETY PRECAUTIONS NOTED ON PAGE 5.

Columbia Forest Products is North America's largest manufacturer of hardwood plywood and hardwood veneer, a leader in sustainable forestry, and innovator of soy-based formaldehyde-free PureBond® technology.

EASY SPECIAL ORDER*: Stock items are available at most Home Depot stores. Don't see what you need on the shelves? Ask the Associates at the ProDesk for assistance to order **anything** you need: species like Cherry, Walnut, Maple or even exotics. Need a special thickness or an MDF or particleboard core? We can get it for you. **As little as 1 sheet**, shipped right to the store. (Ask the ProDesk Associate for lead times and pricing information.)

*At this time, PureBond® plywood is not stocked or offered through special order in The Home Depot stores in AZ, CO, ID, NM, NV, OR, UT, or WA.

- **Return saw to 0° / 90° and cut the pieces length to 19"** (Hint: Again, you may want to cut the Cradle Bottom while the fence is set to exactly 19")
- **Cut arc shape on top edge of Side Panels:** Refer to Figure C.

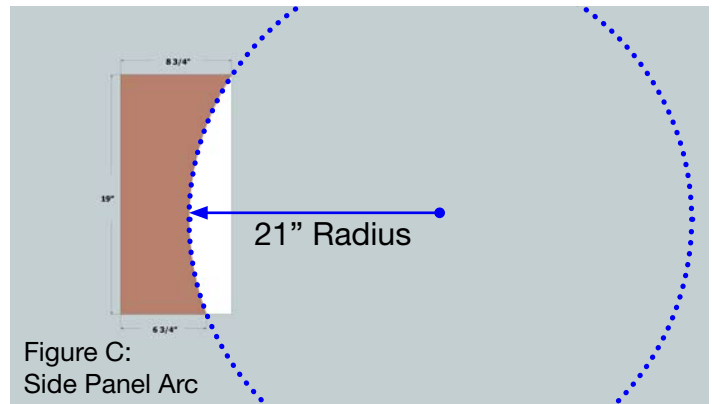

Figure C: Side Panel Arc

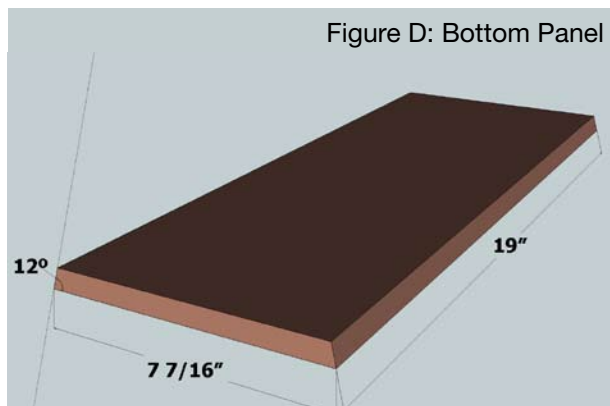

Figure D: Bottom Panel

Step 2

- **Cut Cradle Bottom:** (If not done in previous saw set-ups) See Figures D and E.

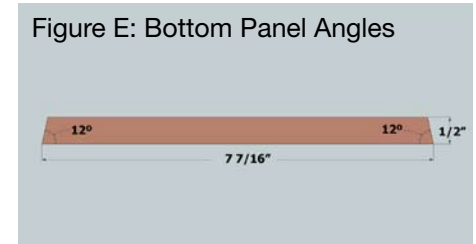

Figure E: Bottom Panel Angles

Doll Cradle - Instructions continued

Step 3

- **Cut Head Board:** Refer to Figure F
- **Cut Foot Board:** Refer to Figure G.

(Hint: Use the Headboard as a template to cut the bottom curves of Footboard & Cradle Supports together on a router table to make sure your rockers match perfectly — Or make headboard first and trace it to cut with scroll saw/band saw) See Figure H for alignment comparison.

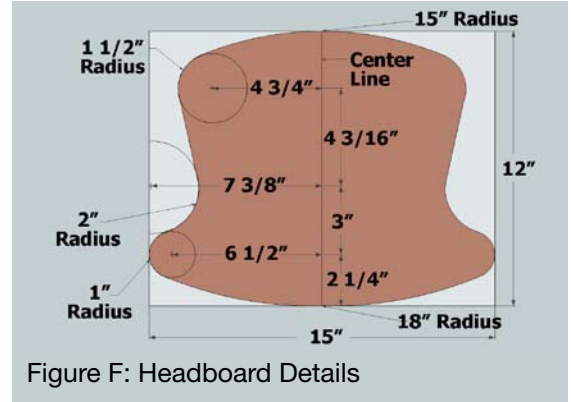

Figure F: Headboard Details

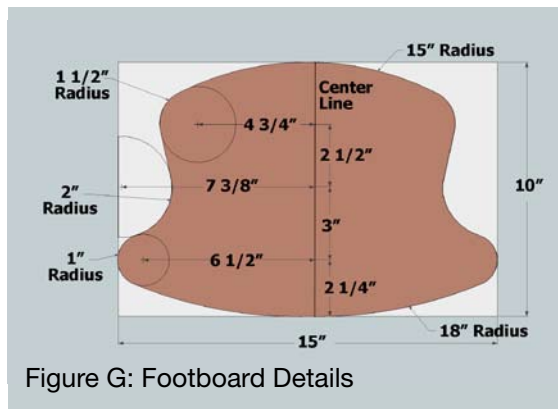

Figure G: Footboard Details

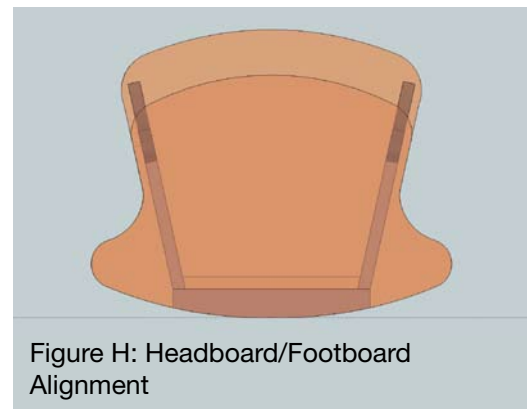

Figure H: Headboard/Footboard Alignment

PLEASE READ AND FOLLOW ALL SAFETY PRECAUTIONS NOTED ON PAGE 5.

Columbia Forest Products is North America's largest manufacturer of hardwood plywood and hardwood veneer, a leader in sustainable forestry, and innovator of soy-based formaldehyde-free PureBond® technology.

EASY SPECIAL ORDER*:

Stock items are available at most Home Depot stores. Don't see what you need on the shelves? Ask the Associates at the ProDesk for assistance to order **anything** you need: species like Cherry, Walnut, Maple or even exotics. Need a special thickness or an MDF or particleboard core? We can get it for you. **As little as 1 sheet**, shipped right to the store. (Ask the ProDesk Associate for lead times and pricing information.)

*At this time, PureBond® plywood is not stocked or offered through special order in The Home Depot stores in AZ, CO, ID, NM, NV, OR, UT, or WA.

Step 4

Apply Edgebanding*

- On Side Panels apply Edgebanding to **TOP EDGE ONLY**. See Figure I.
- On Headboard and Footboard start on the bottom so seam is hidden.

**Follow Manufacturer's Instructions for Edging.*

Figure I: Edging

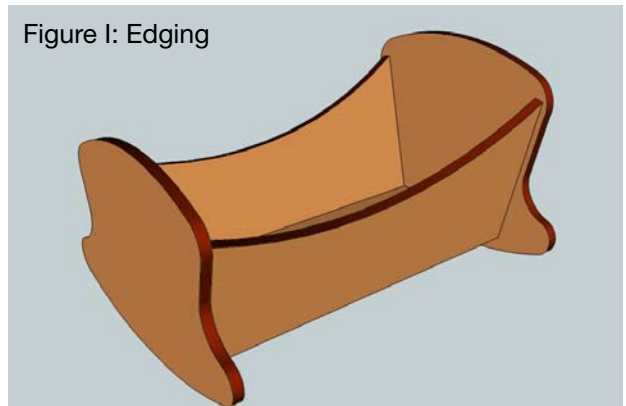
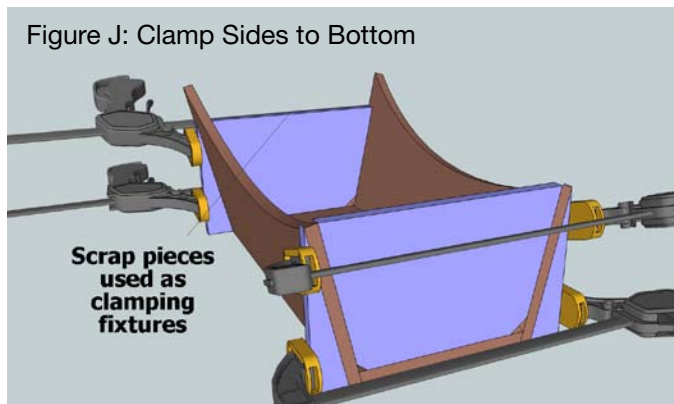

Figure J: Clamp Sides to Bottom



Step 5

Assembly:

- **Glue and Clamp Sides to Bottom** using clamping fixtures if needed. See Figure J.
- **Wait for glue to dry.** (Check manufacturer's directions to find a glue that is appropriate for your veneer faces.)

Doll Cradle - Instructions continued

Step 6

- **Align, clamp and glue Cradle Bottom Support to Headboard & Foot-board.** See Figure K and L.
- **Wait for glue to dry.**
- **Align, Glue and Clamp Sides & Bottom Assembly** (created in first assembly step above) See Figure M.
- **Wait For Glue to dry.**

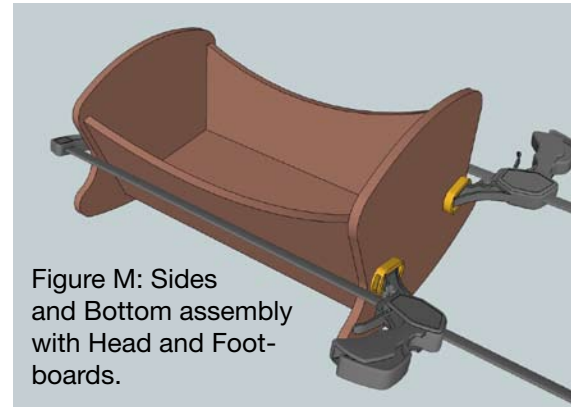
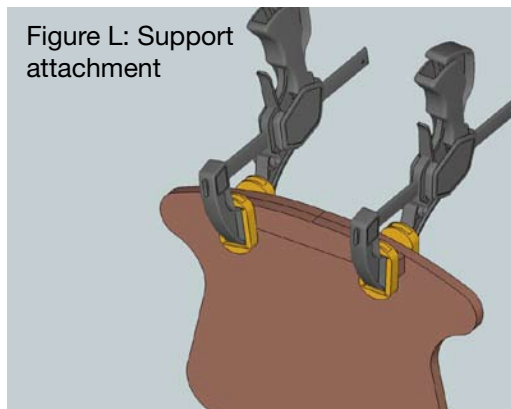
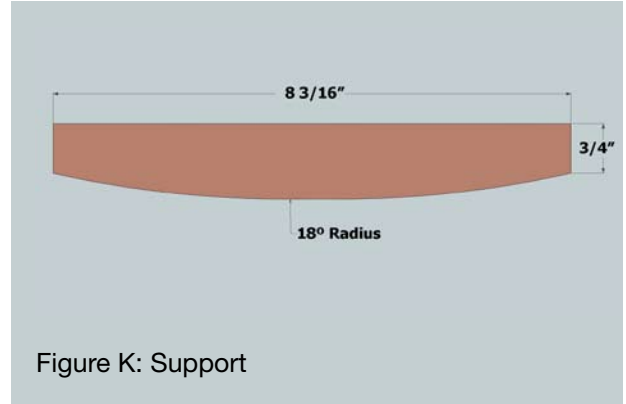

Notes:

- You could use dowel construction or use small brads if needed to attach the sides to the head and footboards. We used glue techniques only which should be more than strong enough for a child's toy.

Warning: This project is intended to be a child's toy and is not safe for use as a cradle for infants.

Safety Precautions

- Read all of the instructions and materials list before cutting or assembling this Doll Cradle.
- Improper assembly could result in damage to your property, or serious injuries. Columbia Forest Products is not liable for any damage or injury resulting from the assembly or use of this Doll Cradle.
- Use caution when cutting. Make sure you are using an appropriate saw and blade, and follow all safety instructions provided by the saw manufacturer.

Disclaimer of Liability and Warranties

The assembly plans for this Doll Cradle are complete and accurate to the best of Columbia Forest Products' knowledge, and are provided free of charge. Columbia Forest Products disclaims any and all liability for injuries or damage resulting from the assembly or use of this Doll Cradle, including any consequential damages. Anyone assembling or using this Doll Cradle does so at their own risk.

Columbia Forest Products makes no warranty of any kind with respect to the assembly or use of this Doll Cradle, and explicitly disclaims any Implied Warranty of Merchantability and/or Implied Warranty of Fitness for a Particular Purpose.

By downloading and/or following these plans, the user acknowledges that he or she has read and followed the Assembly Instructions and Safety Precautions.

Feedback line: info@cfpwood.com.

PLEASE READ AND FOLLOW ALL SAFETY PRECAUTIONS NOTED ON PAGE 5.

Columbia Forest Products is North America's largest manufacturer of hardwood plywood and hardwood veneer, a leader in sustainable forestry, and innovator of soy-based formaldehyde-free PureBond® technology.

EASY SPECIAL ORDER*:

Stock items are available at most Home Depot stores. Don't see what you need on the shelves? Ask the Associates at the ProDesk for assistance to order **anything** you need: species like Cherry, Walnut, Maple or even exotics. Need a special thickness or an MDF or particleboard core? We can get it for you. **As little as 1 sheet**, shipped right to the store. (Ask the ProDesk Associate for lead times and pricing information.

*At this time, PureBond® plywood is not stocked or offered through special order in The Home Depot stores in AZ, CO, ID, NM, NV, OR, UT, or WA.